

Cod. 3010.1804 3010.1805	Tipo - Type VA13 - BP51/C - 35A Aspirante - Suction VA13 - BP51/C - 35S Soffiante - Blowing	Diametro ventola - Fan diameter 330 mm
--	---	--

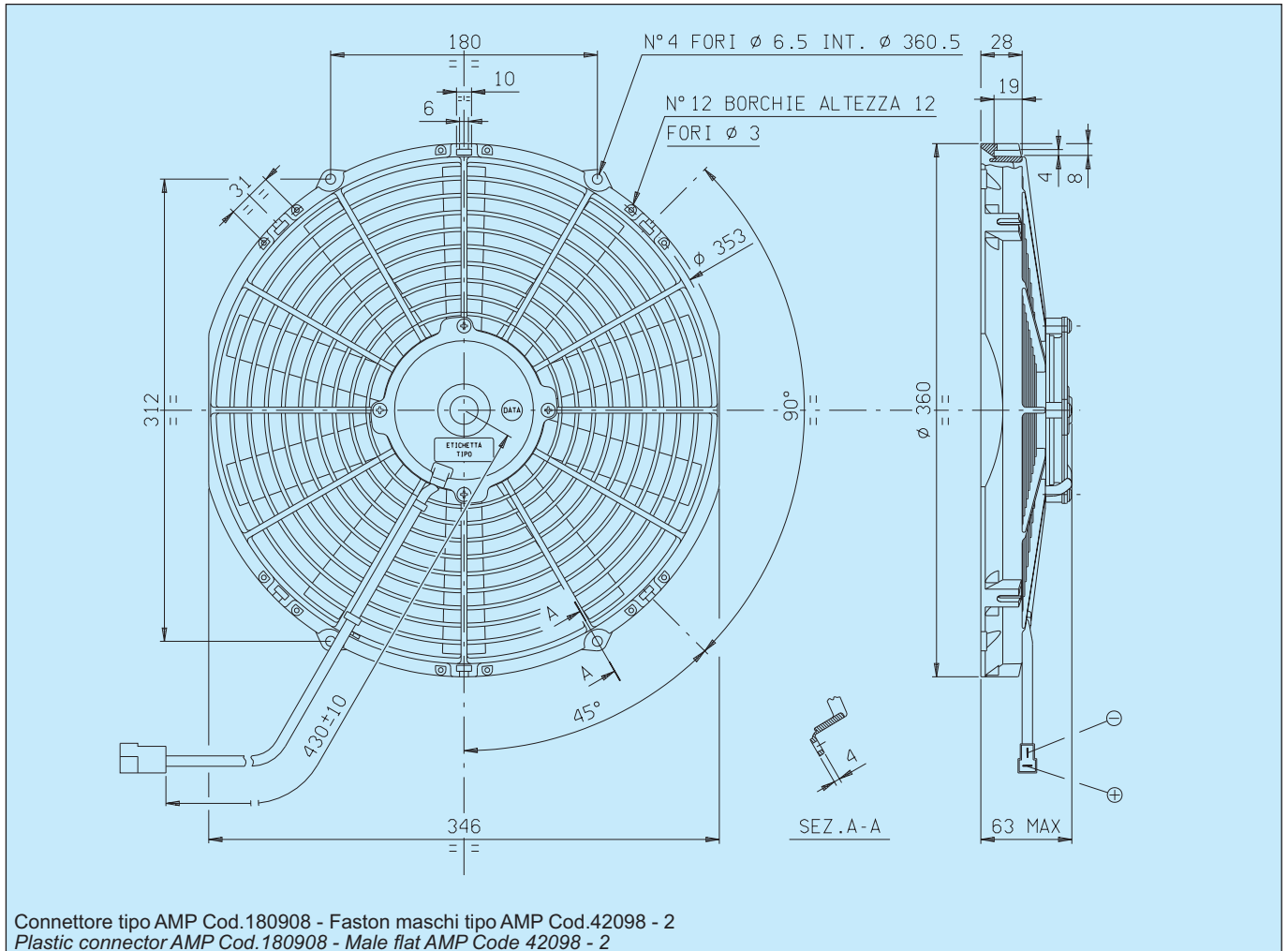

* Peso 1,520 kg. circa * *Weight 1,520 Kg. approx.*

* Motore chiuso, IP 68 * *Waterproof motor, IP 68*

* Lunga durata * *Long life*

* A richiesta (per applicazioni OEM) disponibile anche in versione LL e VLL. * *Available also in LL and VLL versions for OEM applications only.*

* Accessori disponibili: tutti i kit di fissaggio. * *Available accessories: all the fixing kits.*



Tensione di prova 26 V cc - Test voltage 26 V DC

Pressione statica Static pressure mm H ₂ O	Portata Airflow m ³ /h	Corrente assorbita Current input A
0	2130	4,9
2,5	2010	5,1
5	1880	5,3
7,5	1730	5,3
10	1560	5,4
12,5	1370	5,4
15	1080	5,3
17,5	840	5,4
20	580	5,3
25	0	5,2

Static pressure: 1 mm H₂O = 0,04 in. H₂O
Airflow: 1 m³/h = 0,59 cfm