

Cod. 3010.1806 3010.1807	Tipo - Type VA08 - BP51/C - 23A Aspirante - Suction VA08 - BP51/C - 23S Soffiante - Blowing	Diametro ventola - Fan diameter 350 mm
--	---	--

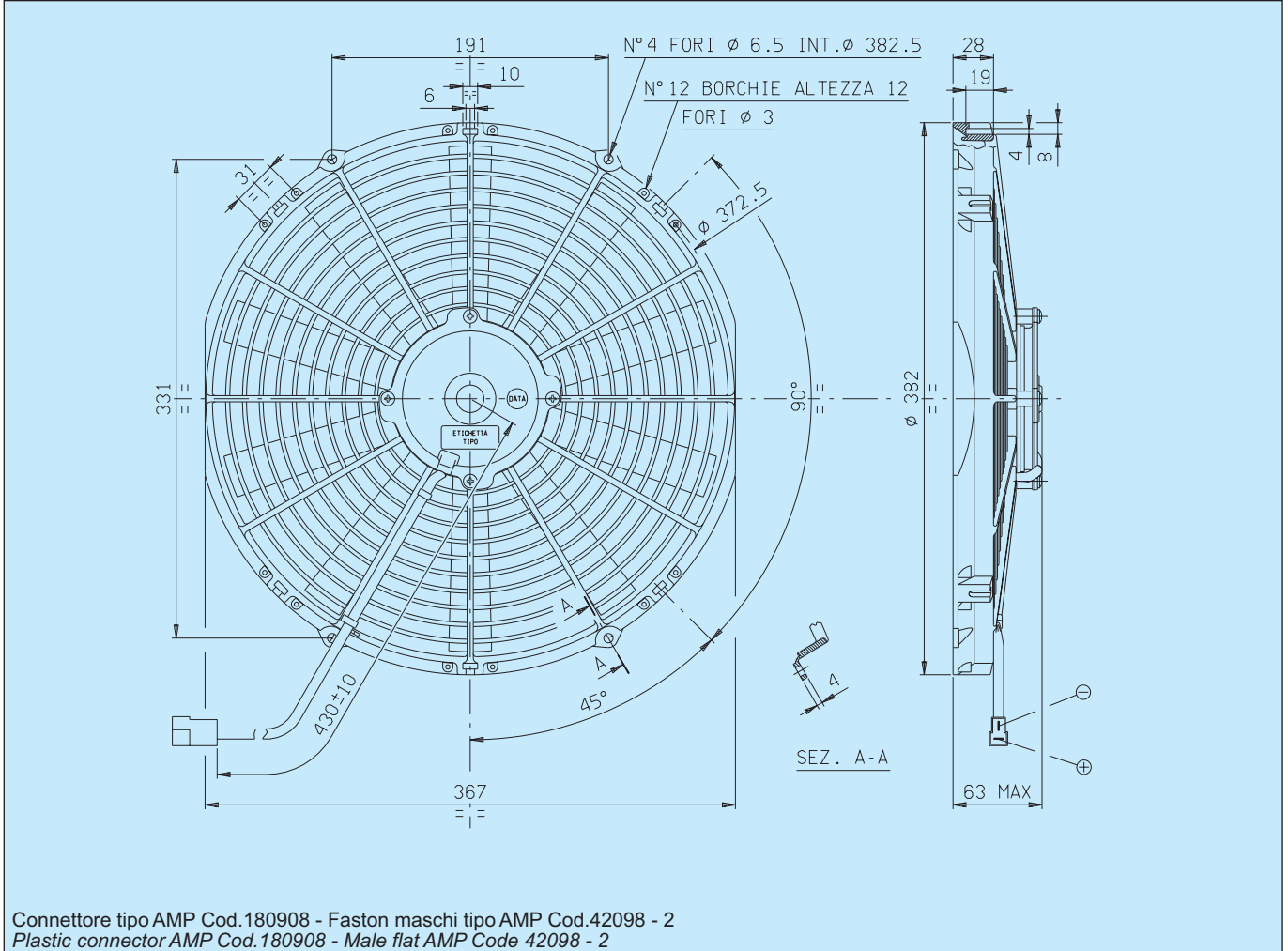

* Peso 1,700 kg. circa * *Weight 1,700 Kg. approx.*

* Motore chiuso, IP 68 * *Waterproof motor, IP 68*

* Lunga durata * *Long life*

* A richiesta (per applicazioni OEM) disponibile anche in versione LL e VLL. * *Available also in LL and VLL versions for OEM applications only.*

* Accessori disponibili: tutti i kit di fissaggio. * *Available accessories: all the fixing kits.*



Tensione di prova 26 V cc - Test voltage 26 V DC

Pressione statica Static pressure mm H ₂ O	Portata Airflow m ³ /h	Corrente assorbita Current input A
0	2200	5,0
2,5	2030	5,2
5	1870	5,3
7,5	1700	5,5
10	1510	5,5
12,5	1250	5,5
15	980	5,3
17,5	690	5,3
20	340	5,2
25	0	5,3

Static pressure: 1 mm H₂O = 0,04 in. H₂O
Airflow: 1 m³/h = 0,59 cfm